



KOREA CARSTOPPER

주식회사 한국카스토퍼

Creative challenges to make better protections for the world

www.carstopper.com



GD마크



조달청
조달계약 등록



GR마크



특허청 마크

green label



ISO마크

CREATIVE CHALLENGES TO MAKE BETTER PROTECTIONS FOR THE WORLD

지나온 23년 그리고 계속해서, 세계를 향한 끊임없는 도전!! 한국카스토퍼

주식회사 한국카스토퍼

경기도 파주시 조리읍 뇌조로178번길 15-67
15-67, Noejo-ro 178beon-gil, Jori-eup, Paju-si, Gyeonggi-do, Korea
TEL : +82-31-944-5771
FAX : +82-31-944-5772
E-MAIL : koreacarstopper@gmail.com
WEB : www.carstopper.com



한국카스토퍼는 1993년 내구성이 우수한 파스콘카스토퍼의 개발을 시작으로, 현재 종합적인 주차 안전시설물을 생산, 공급, 수출하고 있습니다. 정도경영, 속도경영, 창조 경영이라는 기업 철학을 기반으로 앞으로도 최고 품질의 제품을 만드는 장인이 기업이 되겠습니다.

KoreaCarstopper SINCE 1993

For over 20 years, we have been dedicated to making better parking safety products such as car stoppers, corner guards, speed humps and deck bumpers.

We promise! Every Korea Carstopper's products will offer cost-effective protection for existing facilities, easy installation and a wide variety of styles and materials to meet virtually any requirement. Through innovative design, reliable quality and customers, Korea Carstopper Co.,Ltd. intends to take the world in imaginative new directions in this field.













CEO. *Se Jin Park*

(주)한국카스토퍼 나라장터 계약물품현황(조달청)

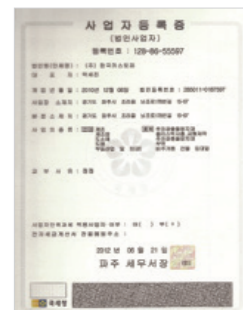
모델명	모델	정보
칼라카스토퍼		규격 : 140(W) × 120(H) × 750MM(L) 재질 : 복합 P.P G2B식별번호 : 20654850 G2B분류번호 : 30121795
파킹블럭		규격 : 140(W) × 120(H) × 600MM(L) 재질 : 복합 P.P G2B식별번호 : 20654855 G2B분류번호 : 30121795
파킹가드		규격 : 150(W) × 120(H) × 900MM(L) 재질 : 복합 P.P G2B식별번호 : 20654853 G2B분류번호 : 30121795
카키퍼		규격 : 130(W) × 110(H) × 750MM(L) 재질 : 복합 P.P G2B식별번호 : 21191549 G2B분류번호 : 30121795
외부용 카스토퍼		규격 : 400(W) × 120(H) × 750MM(L) 재질 : 복합 P.P G2B식별번호 : 21312967 G2B분류번호 : 30121795
고무카스토퍼		규격 : 150(W) × 120(H) × 750MM(L) 재질 : 합성고무 G2B식별번호 : 20654867 G2B분류번호 : 30121795
버스용 카스토퍼		규격 : 180(W) × 160(H) × 800MM(L) 재질 : 합성고무 (N.B.R) G2B식별번호 : 22185751 G2B분류번호 : 30121795
빅 스토퍼		규격 : 200(W) × 180(H) × 1000MM(L) 재질 : Complex coprene G2B식별번호 : 23121819 G2B분류번호 : 30121795

한국카스토퍼의 조달공급은 '현장설치도'입니다.

AUTHENTICATION 인증서

			
GD Certificate	GD상품선정증	greenlabel-carstopper	greenlabel-speed downer
			
ISO	ISO14001 Certificate	공장등록증	사업자등록증
			
실용신안등록증	우수산업디자인 상품선정증	의장등록증-01	의장등록증-02
			
특허증	품질인증서	GR	

주차멈춤턱 장점 및 콘크리트, 아스팔트 시공방법

한국카스토퍼의 주차멈춤턱은 이런 점이 특징이고 장점입니다.

- ① 바퀴가 접촉하는 주차 턱 상단이 55도로 넓게 제작되어 주차시의 충격이 현저히 감소하며 주차 턱 본체에 미치는 차량의 하중이 분산되어 내구성이 상당히 증대됩니다. (실용신안 169742호)
- ② 제품 저면에 드릴링 시 나오는 잔재물을 가둬두는 포켓이 있어 잔재물 제거를 하지 않고 너트를 조여도 견고하게 부착할 수 있습니다.
 - * 파손(깨짐)은 흔들릴 때 차량의 충격이 원인입니다. (실용신안의 일부 항목)
 - * 포켓 없는 제품은 반드시 잔재물 제거를 하고 너트를 조여야만 하므로 관리 감독이 쉽지 않습니다.
- ③ 최상급 배광 성능의 리플렉터(반사경), 선명한 칼라, 사출조건의 최적화, 내부식성 원료 사용.

Features and Strengths of the Car Stopper

- ① Since the top at an angle of 55° Which contacts the wheel is wide, a parking impact is significantly reduced. As load on the car stopper is distributed, its life is increased considerably. (Practical patent No.169742)
- ② Thanks to the pocket for drilling residue, you can tighten nuts without removing residues.
 - * Cracks have an impact on the vehicle. (Part of the practical patent)
 - * Since the products without pocket have to be cleaned of residual material before tightening nuts, they are not easy for supervision.
- ③ The top quality reflector, vivid color, optimized injection molding and corrosion-resistant materials are used.



▲ 콘크리트 표준 시공방법

- ① 후방 주차선에서 1100MM 띄우고 기준선을 설치한다.
- ② 카스토퍼 밑그림판을 기준선에 일치시키고 천공 위치 표시.
- ③ 해머드릴로 ϕ 17, 깊이 50MM의 구멍을 뚫는다.
- ④ 세트 양카를 삽입 타격을 가하여 양카를 고정시킨다.
- ⑤ 카스토퍼를 고정된 양카에 끼우고 너트를 조인다.
- ⑥ 마개를 끼우고 제품 세척 후 마감한다.
 - * 바닥 조건에 따라 전산 볼트, 롱세트앵커를 사용할 수도 있다.

Concrete construction method

- ① Install guide line off 1100mm from a rear parking line.
- ② Fix a car stopper template with the guide line and then mark a drilling site.
- ③ Drill a hole ϕ 17, 50mm depth by a hammer drill.
- ④ Fix an anchor by insert of set anchor.
- ⑤ Insert a car stopper to fixed anchor, tighten the nut.
- ⑥ Complete after put of the cap & cleaning.



▲ 아스팔트(고압블럭) 표준 시공방법

- ① 해머드릴로 ϕ 17, 깊이 120 ~ 150MM의 구멍을 뚫는다.
- ② 블로우건을 이용하여 구멍 속의 잔재물을 제거한다.
- ③ 에폭시 경화제를 구멍에 1/3쯤 채운다.
- ④ 카스토퍼를 구멍에 맞추고 스크루앵커를 삽입, 조인다.
 - * 전지 또는 에어 임팩트 렌치로만 가능함.

Asphalt(high pressure block)construction method

- ① Make holes ϕ 17 and 120~150mm in depth, using a hammer drill.
- ② Clean up the hole using a blow gun.
- ③ Fill the hole with epoxy bond to about 1/3 of depth.
- ④ Align the car stopper with the holes, insert screw bolts, and tighten the screw bolt.
 - * Use an electric or air impact wrench.

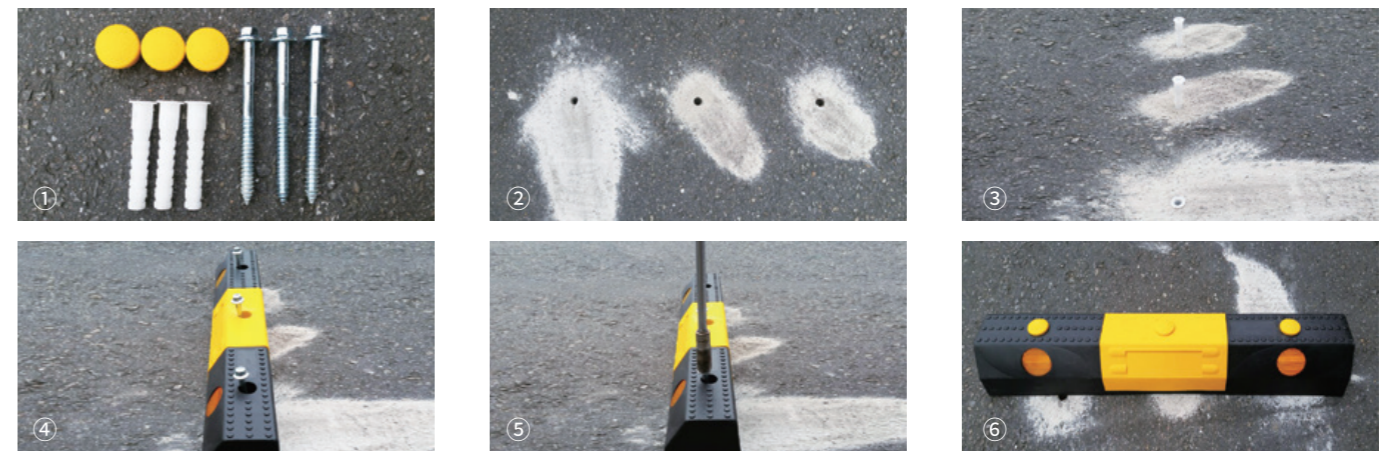

칼라카스토퍼 (HK-1412) COLOR CARSTOPPER (HK-1412)



- MODEL NO : HK-1412
- MATERIAL : COMPLEX P.P
- SIZE : 140(W) × 120(H) × 750MM(L)
- WEIGHT : 4.3KG
- COLOR : YELLOW, ORANGE, GREEN, BLUE & PURPLE

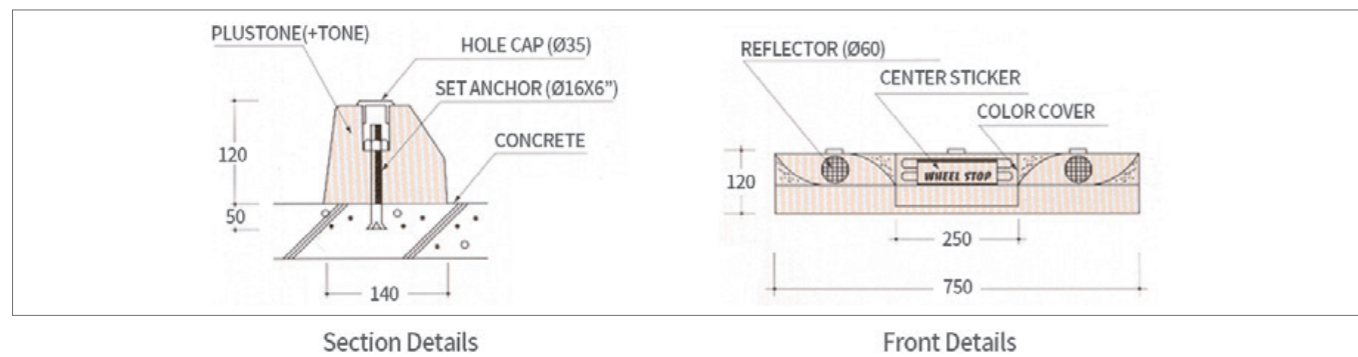

FEATURE

- ① Unique design and vivid color.
- ② The top quality reflectors guarantees smooth parking at night.
- ③ Production by injection process enables the quality and features of the product elaborate and consistent.
- ④ The world's first color car stopper that started being sold in 1998. (Major item of the practical patent)

특징

- ① 디자인과 칼라가 입체적이고 선명하며 그로 인한 시인성이 뛰어나
- ② 우수한 배광 성능의 리플렉터 부착으로 야간 주차유도 배려
- ③ 2000년 산업 자원부로부터 GD(굿디자인) 선정된 제품
- ④ 1998년부터 판매, 세계 최초의 칼라 덮개 타입의 주차 턱 (실용신안의 주항목)

파킹블럭 (HK-1460) PARKING BLOCK (HK-1460)



- MODEL NO : HK-1460
- MATERIAL : COMPLEX P.P
- SIZE : 140(W) × 120(H) × 600MM(L)
- WEIGHT : 3.8KG
- COLOR : BLACK, YELLOW, ORANGE

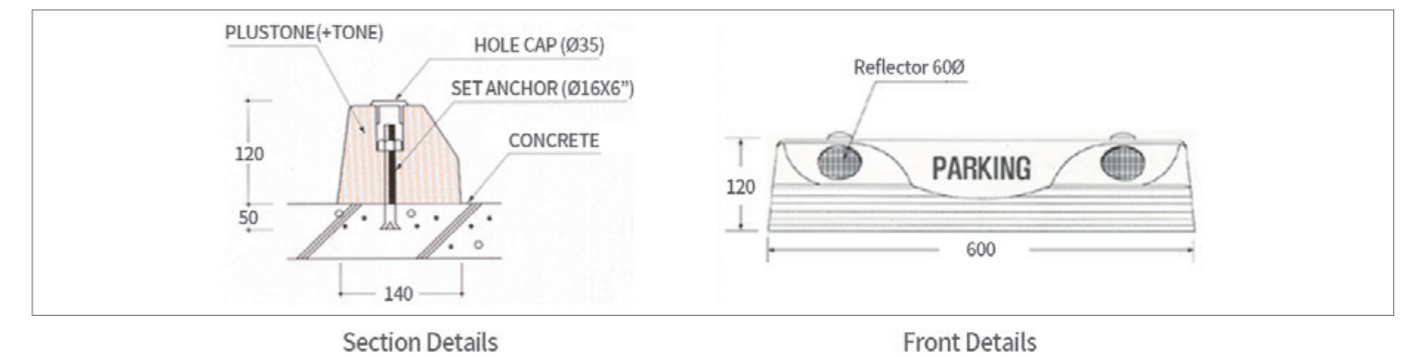

FEATURE

- ① The optimal contact angle with wheels minimizes parking impacts.
- ② Startd to export of Japan in 2001.
- ③ Black is made of recycled materials and color products are made of P.P compounds.

특징

- ① 바퀴와 최적의 접촉각도로 주차 충격 최소화
- ② 2001년부터 시판, 일본 수출의 주력 상품
- ③ 검정 색상은 리사이클 제품. 칼라는 신재 복합 P.P

파킹가드 (HK-1590) PARKING GUARD (HK-1590)



- MODEL NO : HK-1590
- MATERIAL : COMPLEX P.P
- SIZE : 150(W) × 120(H) × 900MM(L)
- WEIGHT : 5.5KG
- COLOR : ORANGE, YELLOW, GREEN, GREY, BLUE

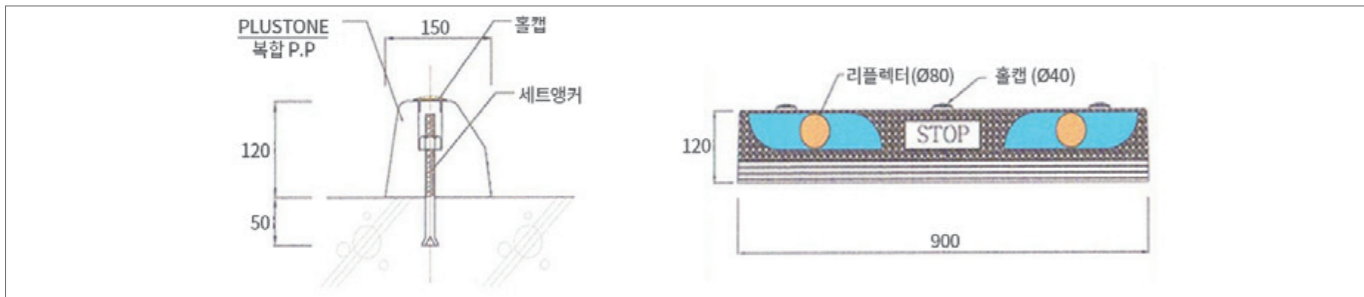

파킹가드 단면상세도

파킹가드 전면상세도

FEATURE

- ① A piece can be installed for a parking space. (But, 2 pieces for a disabled parking spaces)
- ② Better impact resistance thanks to the reinforced structure.
- ③ Product in 2003, this product is highly appreciated in overseas markets.

특징

- ① 주차 1면에 1개 설치 (장애인은 2개)
- ② 2003년부터 시판, 해외 호응도 최상
- ③ 부챗살 구조의 보강살로 내충격성 우수
- ④ LH공사 규격 사양의 제품 (주택공사)

카키퍼 (HK-1311) CAR KEEPER (HK-1311)



- MODEL NO : HK-1311
- MATERIAL : COMPLEX P.P
- SIZE : 130(W) × 110(H) × 750MM(L)
- WEIGHT : 3.5KG
- COLOR : BLACK, YELLOW, GREEN, ORANGE

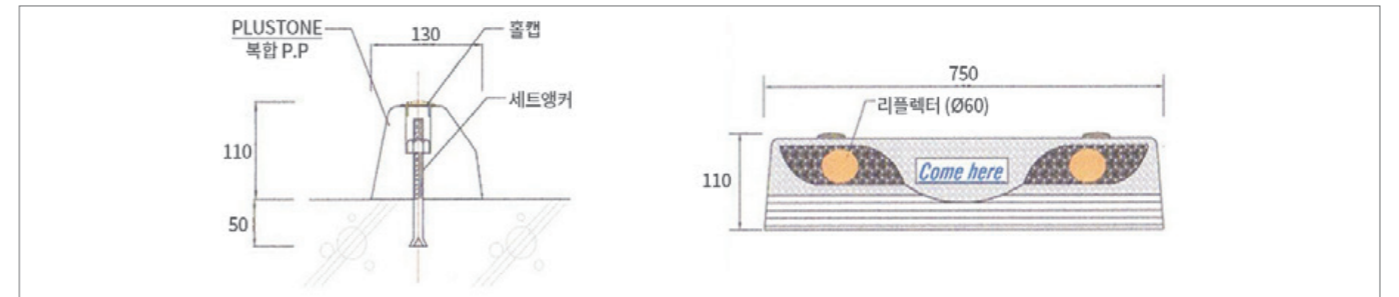

카키퍼 단면상세도

카키퍼 전면상세도

FEATURE

- ① Simple look and impact resistant structure.
- ② LDPE logo resistant to contamination and damage.

특징

- ① 심플한 외관 및 내충격 구조의 격벽
- ② 오염, 훼손 없는 합성수지(LDPE) 로고 부착

외부용카스토퍼 (HK-40777) OUTDOOR CARSTOPPER (HK-40777)



- MODEL NO : HK-40777
- MATERIAL : COMPLEX P.P
- SIZE : 400(W) × 120(H) × 777MM(L)
- WEIGHT : 7.0KG
- COLOR : BLACK, GREEN & ORANGE

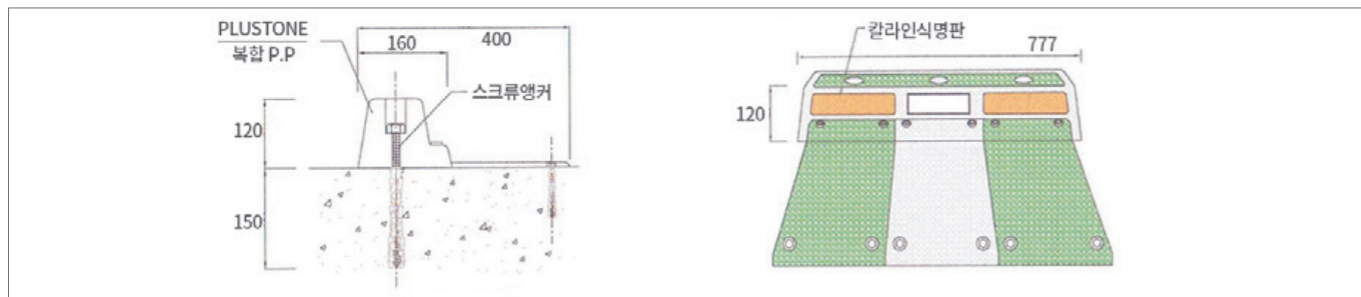

외부용카스토퍼 단면상세도

외부용카스토퍼 전면상세도

FEATURE

- ① Strong installation with nine anchors.
- ② Customer's name or logo and production dates can be printed on the face of product.
- ③ In 2009, acquirement of the GD mark and patent.

특징

- ① 상호, 로고, 마크 등 홍보 내용의 인쇄 가능
- ② 총 9개의 앵커로 단계별 견고한 고정
- ③ 본체 상단은 잔디를 자라게 할 수 있는 친환경적인 보다 진보된 주차턱
- ④ 2009년 굿디자인(GD) 상품 선정, 특허 취득

고무 카스토퍼 (HKR-1512) RUBBER CARSTOPPER (HKR-1512)



- MODEL NO : HKR-1512
- MATERIAL : COMPLEX RUBBER
- SIZE : 150(W) × 120(H) × 750MM(L)
- WEIGHT : 6.0KG
- COLOR : BLACK

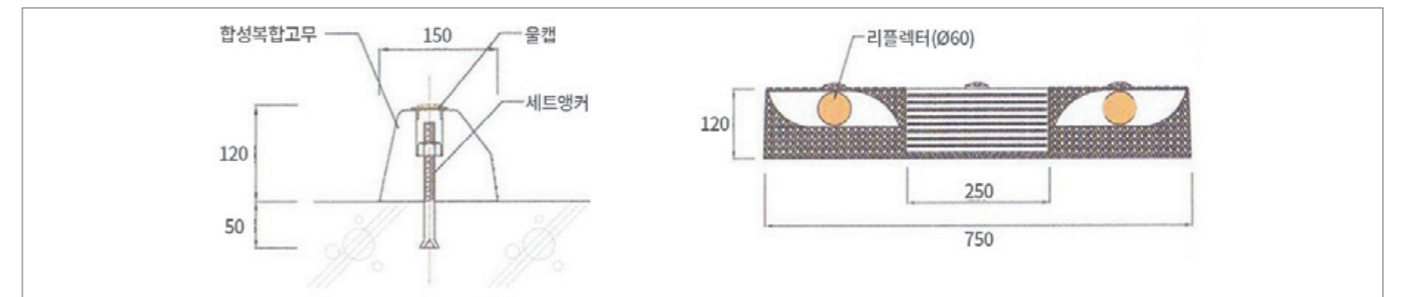

고무카스토퍼 단면상세도

고무카스토퍼 전면상세도

FEATURE

- ① Maximum hardness by combining rubber and P.V.C.
- ② The top resistance to impact, pollution and ozone.
- ③ The first buried reflector for rubber car stoppers.
- ④ Press injection molding for consistent quality and look.

특징

- ① 고무와 경질 P.V.C의 합성으로 경도 극대화
- ② 품질 및 외관이 균일한 프레스 방식의 사출
- ③ 내충격, 내오염, 내오존성 등 내구성 최상
- ④ 고무제품 최초로 매립식 리플렉터 채용

칼라 고무카스토퍼 (HKR-1412)

COLOR RUBBER CARSTOPPER (HKR-1412)



- MODEL NO : HKR-1412
- MATERIAL : COMPLEX RUBBER(BODY) + P.P(COLOR COVER)
- SIZE : 140(W) × 120(H) × 750MM(L)
- WEIGHT : 5.0KG
- COLOR : YELLOW, ORANGE, GREEN, BLUE & PURPLE

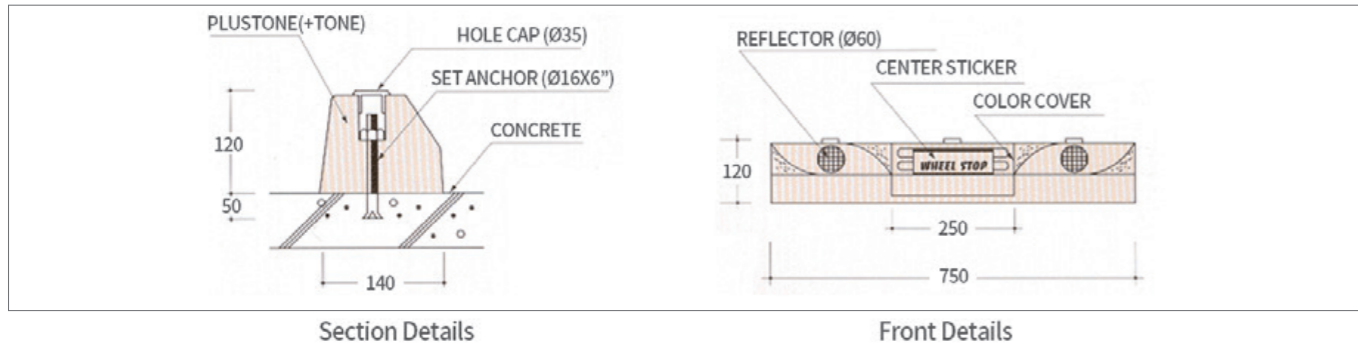

FEATURE

- ① Color cover employed on the rubber body.
- ② It combines the first identifiable capabilities the durability of rubber.

특징

- ① 고무 본체에 칼라커버 적용
- ② 고무의 내구성에 시인 성능을 결합한 최초 제품.

버스용 카스토퍼 (HKR-1816)

BUS & TRUCK STOPPER (HKR-1816)

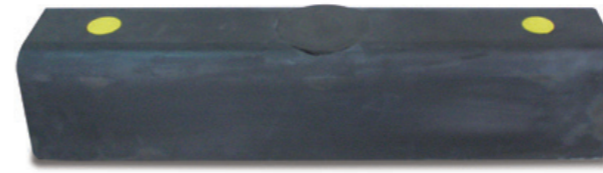

- MODEL NO : HKR-1816
- MATERIAL : SYNTHETIC RUBBER
- SIZE : 180(W) × 160(H) × 800MM(L)
- WEIGHT : 25KG
- COLOR : BLACK

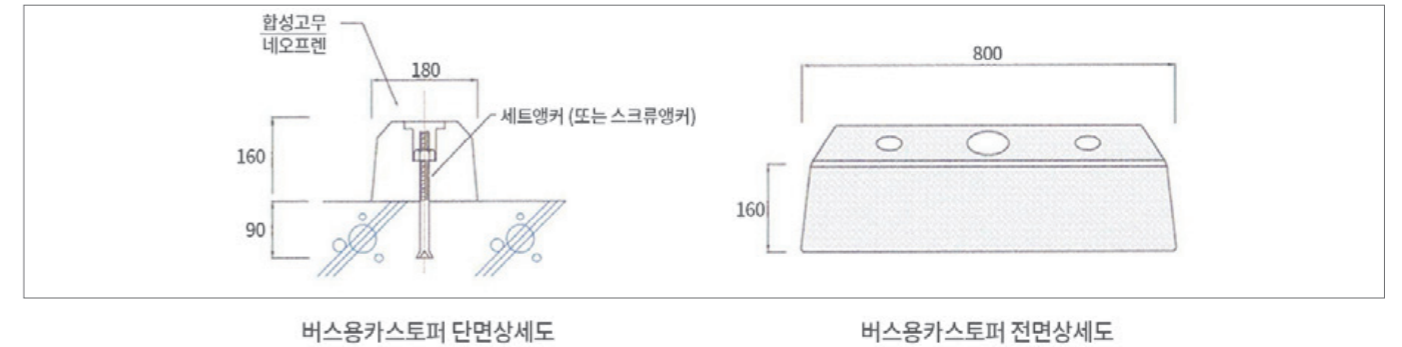

FEATURE

- ① Parking stoppers for 2.5 ~ 40ton vehicles.
- ② Applicable for rubber tire vehicles only. (Not for tracked vehicles)
- ③ Excellent durability, and resistance against impact and pollution.
- ④ Easy to install and remove it in snow season.

특징

- ① 2.5 ~ 40톤 정도의 중량용 주차멈춤턱
- ② 바퀴가 고무 소재인 차량만 해당 (궤도 차량은 사용 불가능)
- ③ 내충격, 내오염등 내구성 양호
- ④ 외관이 균일한 프레스 방식으로 생산

빅 스토퍼 (HK-2018)

BIG STOPPER (HK-2018)



- MODEL NO : HK-2018
- MATERIAL : COMPLEX COPRENE
- SIZE : 200(W) × 180(H) × 1000MM(L)

- WEIGHT : 20KG
- LOAD CAPACITY : 80 TONS
- COLOR : YELLOW, ORANGE, GREEN, BLUE

FEATURE

- ① Injection producing
- ② Excellent quality / Appearance
- ③ Durability
- ④ Identity
- ⑤ By application diversity
- ⑥ Efficient by dry workability

특징

- ① 사출 생산
- ② 우수한 품질 / 외관
- ③ 내구성
- ④ 식별성
- ⑤ 조합의 다양성
- ⑥ 건식의 효율적 작업성

코너가드

CORNER GUARD

CORNER GUARD (HK-9090)

- MODEL NO : HK-9090
- MATERIAL : MILD P.V.C
- SIZE : 90(RW) × 90(LW) × 1000MM(H)
- COLOR : BLACK, GREY AND YELLOW STRIPES
(* AVAILABLE COLOR RANGE : ALL YELLOW, GREY)
- HOW TO INSTALL
· FIXING BY STEEL FRAME WITH TORQUE ANCHOR.



CIRCULAR COLUMN GUARD (HK-1815)

- MODEL NO : HK-1815
- MATERIAL : MILD P.V.C
- SIZE : 180(W) × 15(T) × 3000MM(H)
- COLOR : BLACK, GREY AND YELLOW STRIPES
(* AVAILABLE COLOR RANGE : ALL YELLOW, BLACK, GREY)
- HOW TO INSTALL
· FIX GUARD WITH TORQUE ANCHORS.



H-BEAM CORNER GUARD

- MODEL NO : 15T, 18T, 20T, 25T, 30T, 35T, 40T
- MATERIAL : MILD P.V.C
- COLOR : BLACK, GREY AND YELLOW STRIPES
- CUSTOM : SIZES AVAILABLE
- HOW TO INSTALL
· INSTALL WITH TORQUE ANCHORS AND BOND WITH CONSTRUCTION ADHESIVE.



접착식 코너보호대

- MODEL NO : HK-1010
- MATERIAL : EVA
- COLOR : YELLOW, BLACK
- SIZE : 100(RW) × 100(LW) × 1000MM(H)
- HOW TO INSTALL
· INSTALL WITH TORQUE ANCHORS AND BOND WITH CONSTRUCTION ADHESIVE.



과속방지턱 SPEED HUMP

SPEED HUMP 500

- MODEL NO : HKR-500
- MATERIAL : SYNTHETIC RUBBER
- STANDARD : MIDDLE PIECE-500(W) × 50(H) × 500MM(L)
END PIECE-500(W) × 50(H) × 250MM(L)
- COLOR : BLACK, YELLOW

FEATURE

- ① Convenient item to ensure traffic safety in parking lots, other pedestrian and residential areas.
- ② Easy to install and remove.
- ③ Customizable to fit any length requirement.



SPEED HUMP 1000

- MODEL NO : HKR-1000
- MATERIAL : SYNTHETIC RUBBER
- STANDARD : MIDDLE PIECE-1000(W) × 75(H) × 500MM(L)
END PIECE-1000(W) × 75(H) × 250MM(L)
- COLOR : BLACK, YELLOW

FEATURE

- ① Yellow rubber striping alerts vehicles to reduce speeds.
- ② Solid rubber conforms to pavement.
- ③ Customizable to fit any length requirement.



COMPLEX P.P SPEED HUMP

- MODEL NO : HKP-400
- STANDARD : MIDDLE PIECE-400(W) × 50(H) × 500MM(L)
END PIECE-400(W) × 50(H) × 250MM(L)
- AVAILABLE COLORS : BLACK, YELLOW, ORANGE, GREEN

FEATURE

- ① Good visibility thanks to harmony of color.
- ② Available in vivid color.
- ③ Easy to install because it is installed with epoxy bonds and anchors.
- ④ Length without limit by assembling pieces.
- ⑤ Installation by dry-process minimizes time and cost.



E.P.D.M RUBBER SPEED HUMP

- MODEL NO : HKR-400
- STANDARD : MIDDLE PIECE-400(W) × 50(H) × 500MM(L)
END PIECE-400(W) × 50(H) × 250MM(L)
- COLOR : BLACK, YELLOW
(WITH THE VARIOUS SHAPES, YOU CAN COMBINE 48 PATTERNS)

FEATURE

- ① Polished design and various patterns.
- ② Easy installation by fixing anchors.
- ③ Excellent durability.



2M 과속방지턱

- MODEL NO : HKR-2000
- MATERIAL : SYNTHETIC RUBBER
- STANDARD : MIDDLE PIECE-2000(W) × 75(H) × FREE(L)
- COLOR : BLACK, YELLOW

FEATURE

- ① Semi-permanent and partially repairable.
- ② Easy installation. (takes 30 minutes or less)
- ③ Endures heavy load.
- ④ Great visibility with contrasting colors and reflective sheets attached.
- ⑤ No decolorizing.
- ⑥ Various sizes available.



데크범퍼 DECK BUMPER

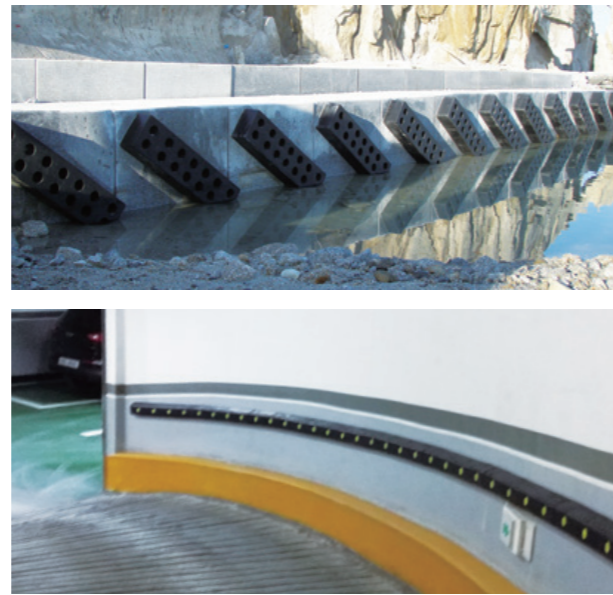

MODEL NO.	MATERIAL	SIZE	COLOR
HKR-1345	SYNTHETIC RUBBER	130(W) × 45(H) × 1000MM(L)	BLACK
HKR-1580	SYNTHETIC RUBBER	150(W) × 80(H) × 1000MM(L)	BLACK
HKR-2010	SYNTHETIC RUBBER	200(W) × 100(H) × 1000MM(L)	BLACK
HKR-2015	SYNTHETIC RUBBER	200(W) × 150(H) × 750MM(L)	BLACK
HKR-2515	SYNTHETIC RUBBER	250(W) × 150(H) × 1000MM(L)	BLACK

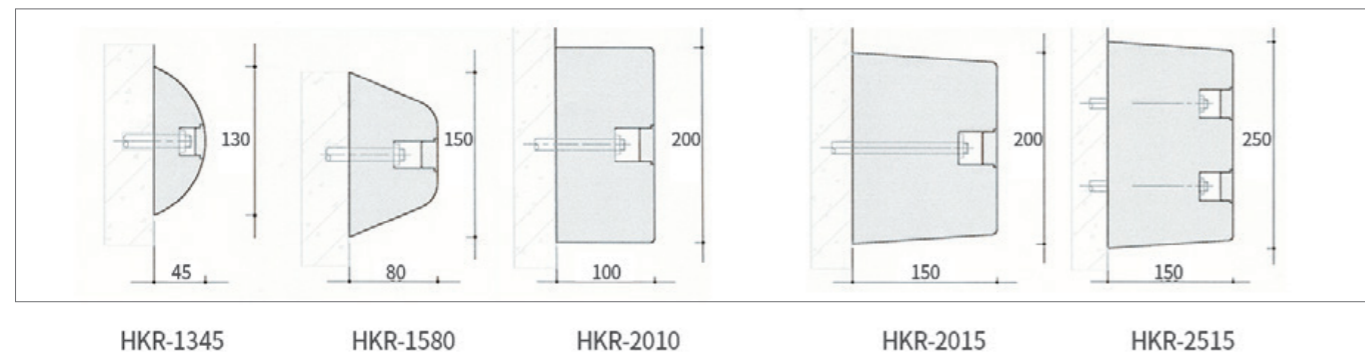

FEATURE

- ① Deck bumpers offer complete protection across a wide variety of demanding applications.
- ② Unique rubber bumpers provide maximum impact resistance.
- ③ Maximum protection for buildings equipment and vehicles.

교통안전용품 TRAFFIC SAFETY GOODS

ROAD SLOPE (보차도연결턱)

MODEL NO.	MATERIAL	SIZE
HK-100	COMPLEX P.P	100(H) × 350(W) × 800MM(L)
HK-130	COMPLEX P.P	130(H) × 350(W) × 800MM(L)
HK-140	COMPLEX P.P	140(H) × 350(W) × 800MM(L)
HK-170	COMPLEX P.P	170(H) × 550(W) × 800MM(L)
HK-200	COMPLEX P.P	200(H) × 550(W) × 800MM(L)



GUIDE POST (탄력봉)

- MODEL NO : HKR-845, HKR-875
- MATERIAL : POLYURETHANE AND REFLECTIVE SHEET
- SIZE : ϕ 80 × 450MM(H), ϕ 80 × 750MM(H)

FEATURE

- A. Good elasticity and dynamic stability.
- B. Good night visibility due to quality reflector.
- C. Highly resistant against pollution.



BOLLARD (양카형 고정볼라드)

- MODEL NO : HK-155
- MATERIAL : POLYURETHANE
- COLOR : BLUE, GRAY
- SIZE : ϕ 155 × 800MM(H)

특징

- ① 우레탄 성형 직전 제품의 틀을 회전하여 제품의 밀도가 높고 쉽게 찢어지거나 흠이 나지 않는다.
- ② 색상이 쉽게 변색되거나 변형이 가지 않는다.



BOLLARD (양카식 슬림볼라드)

- MODEL NO : HK-120
- STANDARD : POLYURETHANE
- COLOR : DARK, GRAY
- SIZE : ϕ 120 × 1000MM(H)

특징

- ① 우레탄 밀도가 높고, 두꺼우며 튼튼하다.
- ② 색상이 쉽게 변색되거나 탈색 되지 않는다.

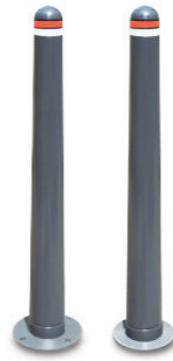

SUPER CONE (슈퍼콘)

- MODEL NO : HK-520
- MATERIAL : HDPE
- SIZE : 520 × 520 × 1000MM(H)



CONVEX SAFETY MIRROR (반사경)

- MODEL NO : HKM-1000, HKM-800, HKM-600
- MATERIAL : STAINLESS STEEL
- SIZE : ϕ 1000, ϕ 800, ϕ 600
- TRIM COLOR : ORANGE
- HOW TO FIX : WALL OR POLE BRACKET

특징

- The stainless steel convex safety mirrors are designed to assist road safety and ensure maximum visibility.
- Unbreakable and impact resistant.
- Indoor or outdoor use.
- Low maintenance.
- Designed to withstand extreme weather conditions.



ROAD STUD (표지병)

- MODEL NO : HK-2001
- MATERIAL : ALUMINUM ALLOY BODY WITH 1 OR 2 PC
- SIZE : 130 × 110 × 30MM



BRAILLE TILE (점자블럭)

- HOW TO FIX : ADHESIVE TYPE OR SCREW FIXING TYPE
- MATERIAL : PORCELAIN
- SIZE : 300 × 300 × 7T

특징

Easy to stick, Indoor use.

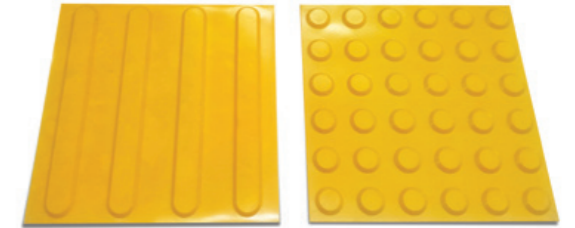

- HOW TO FIX : SCREW FIXING TYPE
- MATERIAL : STAINLESS STEEL BODY + PVC DOMES
- SIZE : 300 × 300 × 7T

특징

Easy to install with 4 screws, Indoor or outdoor use, PVC dome are not separate from stainless steel body.

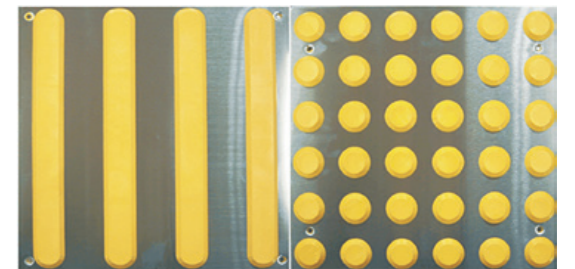

장애인 전용 주차표시판

① 벽면부착형

- MATERIAL : 포맥스 or 스테인리스 스틸
- SIZE : 700 × 600MM

특징

변색이 없으며 내충격성 우수

② 양카고정형

- MATERIAL : 스테인리스 스틸
- SIZE : 700 × 600 × 2100MM × ϕ 50

특징

실외 사용에 적합하며 스테인리스 재질로 내구성이 우수



www.carstopper.com



주식회사 한국카스토퍼

Creative challenges to make better protections for the world

경기도 파주시 조리읍 뇌조로178번길 15-67

15-67, Noejo-ro 178beon-gil, Jori-eup, Paju-si, Gyeonggi-do, Korea

TEL : +82-31-944-5771 FAX : +82-31-944-5772 E-MAIL : koreacarstopper@gmail.com